

# Using Optical Communication for Remote Underwater Robot Operation

Marek Doniec, Carrick Detweiler, Iuliu Vasilescu, Daniela Rus  
Computer Science and Artificial Intelligence Lab  
Massachusetts Institute of Technology  
Cambridge, MA 02139, USA  
{doniec, carrick, iuliu, rus}@mit.edu

**Abstract**—Underwater vehicles are typically operated using a tether or a slow acoustic link. We present an underwater optical communication system that enables a high-throughput and low-latency link to an underwater robot. The optical link allows the robot to operate in cluttered environments without the need for a tether. We demonstrate the performance of the system in a number of experiments which characterize the optical link and demonstrate remote control of the robot using a human input device.

## I. INTRODUCTION

Marine scientists would like to use underwater robot systems to improve their understanding of the underwater world. However, current underwater robot systems are limited to open waters where few obstacles exist and there is little need for real-time feedback and control. One reason for this limitation is that cluttered and dynamic environments prevent the use of a tether between the underwater robot and the user. Reefs, rocks, and other items will quickly tangle the tether, hindering and possibly damaging the vehicle or the environment. Our goal is to develop a system that allows real-time, high-bandwidth communication with an underwater robot system to enable operation in cluttered and dynamic waters such as in coral reef environments.

On land, radio communication usually allows systems to operate wirelessly. Unfortunately, radio does not work underwater because water absorbs most electromagnetic radiation. Acoustic modems are the most commonly used underwater communication system with ranges of several km. Acoustic communication, however, is extremely slow (only hundreds of bits per second) with high latency due to reflections and the relatively slow speed of sound underwater. Thus, it is not possible to dynamically control underwater vehicles remotely using acoustic communication in real-time.

Instead of using a tether or an acoustic modem, we developed a wireless underwater optical modem. In this paper, we present the design and experimental results of a system to control our underwater robot (Autonomous Modular Optical Underwater Robot or AMOUR) in real-time using our optical modem link. Our optical modem achieves high bandwidth (megabits per second) and low latency while maintaining good coverage of the area of operation of the robot. Figure 1 shows a picture of AMOUR and our optical communications system.

Our optical modem allows a land-based user to remotely operate the robot using our human input device (HID) in real-time. The system achieves real-time control due to

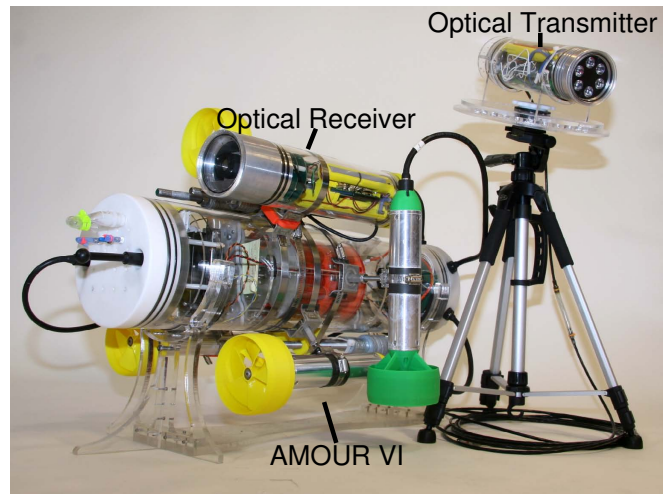

Fig. 1. The optical transmitter mounted to a tripod (right) together with the optical receiver mounted to AMOUR.

the high speed and low latency optical link. We analyze the performance of our system in a pool. In nearly all positions and orientations over a 100 square meter area, our robot successfully receives optical commands from a single stationary transmitter.

We envision using this optical link to quickly update the mission goals and parameters of multiple autonomous robots. The optical link will also enable reception of high fidelity images and videos from the robots. Already, the optical modem has sufficient bandwidth available to allow the real-time operation of tens of robots in parallel with spare bandwidth for relay of images or video. The current system is uni-directional; however, we can easily add a transmitter on the robot to enable a bi-directional link allowing, for instance, the transmission of live video from the robot.

The rest of the paper is organized as follows. We start by discussing related work in Section II. We then outline the system design and hardware platforms in Section III. Next, we present the results of a number of experiments verifying our system in Section IV. Finally, we conclude and discuss future extensions to the system in Section V.

## II. RELATED WORK

The recent advancement of high powered blue-green lasers and LEDs has enabled the development of underwater optical communication systems. A number of studies explored the

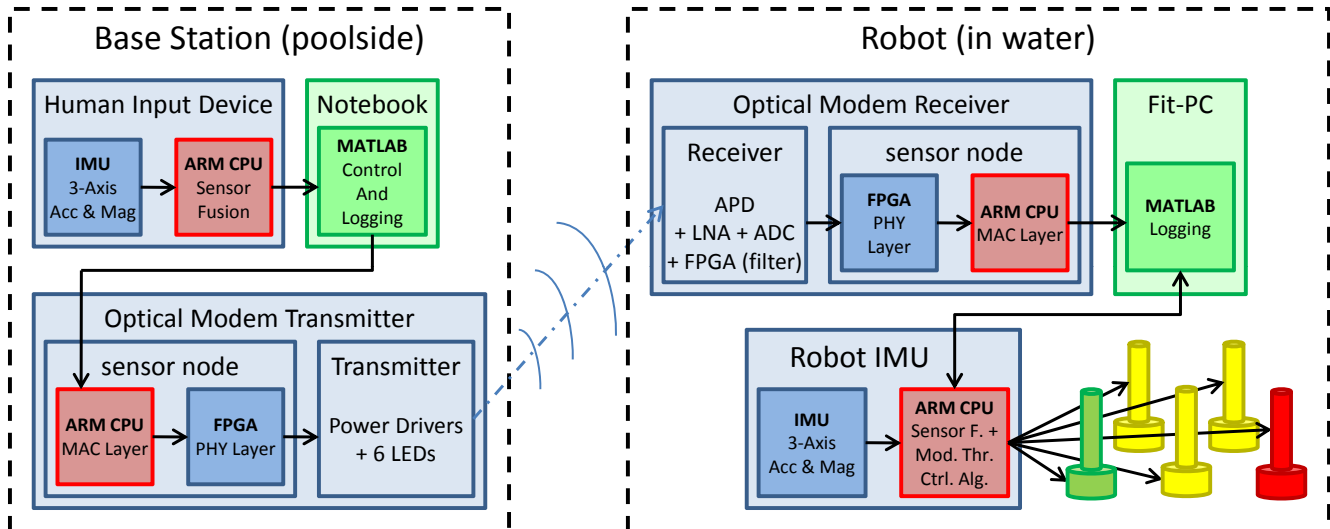

Fig. 2. System overview showing the data path through all modules. The optional HID forwards data to a notebook computer. The computer runs a user interface for desired robot attitude, depth, and speed control and forwards this data to the optical modem transmitter. The transmitter encodes the signal using DPIM and transmits it optically. The optical modem receiver decodes the received pulse train into the desired robot state and forwards this information to the Fit-PC located inside the robot. The Fit-PC forwards this information to the robot’s IMU. It also logs both the data from the optical modem as well as the robot’s current position which it receives from the IMU. Finally, the IMU uses the Modular Thruster Control Algorithm [1] to compute thruster updates.

theory of optical transmission in water and suggested possible optical modem designs [2], [3], [4], [5]. Tsuchida *et al.* reported an early underwater analog communication system for wirelessly monitoring crayfish neuronal activity in [6]. Schill *et al.* created an underwater optical system by combining blue-green LEDs with an IrDA physical layer with the intent of communicating between a swarm of underwater robots [7]. Hanson and Radic proposed the use of waveguide modulated optically lasers for high speed optical communication [8]. Farr *et al.* discussed the possibility of using optical communication for control of underwater vehicles and presented the results of an early prototype optical communication system [9]. They implemented optical remote control of an underwater robot in [10]. Their system operates at depths of at least 1000m where there is little or no ambient light present.

We reported the first use of short-range optical communication for underwater networking in [11], [12] and discussed the details of our long range optical modem system in [13]. We presented the latest version of our underwater robot system and the human input device in [1]. To the best of our knowledge, this paper presents the first results for remotely controlling an underwater vehicle in real-time using a wireless optical link in shallow waters where ambient light is present.

### III. SYSTEM DESIGN AND HARDWARE

Our system allows control of an underwater robot via an optical link. The system consists of three high level components: (1) the base station, which provides an interface for the user to control the robot, (2) the optical modem, which forms the wireless communication link between the base station and the robot, and (3) our underwater robot, AMOUR, which is capable of motions in 6 degrees of



Fig. 3. The Optical Transmitter (left) and the Optical Receiver (right).

freedom. The base station is further divided into a laptop computer running a specially designed user interface (UI) and a human input device (HID) which allows the user to directly control the robot’s attitude. Figure 2 presents an overview of the system. In the following subsections, we present the core hardware modules and the software running on each module.

#### A. Hardware

The hardware consists of the optical modem, our underwater robot, and our human input device. The HID is a handheld Inertial Measurement Unit (IMU) that we described in detail in [1]. We first present the optical modem hardware and then the underwater robot.

1) *Optical Modem:* In [13], we presented previous versions of our optical modem. In this paper, we improve the long range optical modem system by upgrading the receiver to include an on-board convolutional decoder implemented in an FPGA.

The optical modem consists of two modules: the transmitter and the receiver. Figure 3 shows the transmitter and receiver. They are housed in cylindrical bodies with a

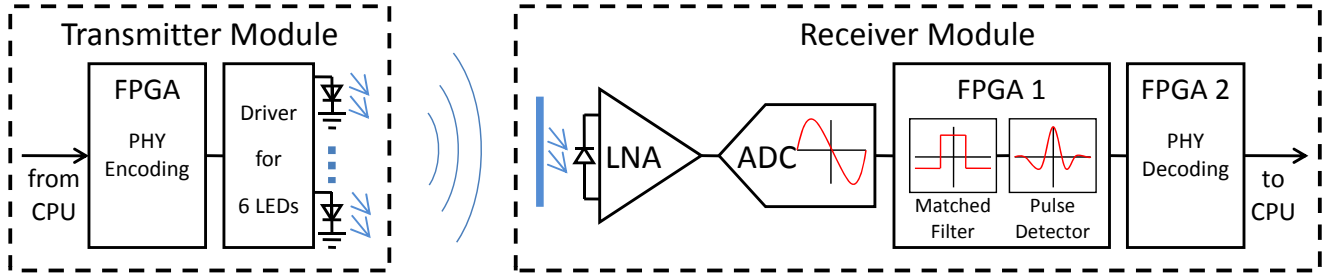

Fig. 4. Optical Modem System Overview.

diameter of 8cm. The transmitter is 30cm in length and the receiver is 35cm long. The approximate weight is 1.7kg for the transmitter and 2.0kg for the receiver module.

Figure 4 outlines the optical modem system. The transmitter contains six high current drivers that pulse six 5W, 480nm LEDs at up to 2MHz with a minimum pulse length of 100ns. The receiver converts the incoming signal using an Avalanche Photodiode (APD). The APD current output is then amplified by a built-in low noise amplifier (LNA), which generates a voltage of  $9.5 \cdot 10^5$  Volts per Watt of incident light. This signal is digitized by an analog to digital converter (ADC) at up to 40 Mega samples per second (MSPS) with a resolution of 12 bits. The resulting signal is analyzed in an FPGA using a matched filter with the expected pulse shape. The convoluted signal from the matched filter is analyzed for spikes to detect the occurrence of pulses in the original signal. Although the system can detect spikes as low as 1.2mV, we calibrated the decoder to reject all pulses weaker than 5mV. This helps eliminate over 99% of all false pulse detections.

The filtered pulse signal then feeds into a hardware subsystem based on our underwater sensor node [12]. This hardware provides an ARM7 processor, a low power FPGA, battery management hardware, and storage through both a FRAM and a mini SD card slot. The processor handles the MAC layer of the optical communication while the FPGA provides physical layer encoding and decoding. The physical layer encoding scheme used on the optical modem is DPIM (Digital Pulse Interval Modulation).

2) *Robot*: The vehicle used during the experiments is the sixth iteration of our in-house developed AUV AMOUR. This version was described in [1].

For the purpose of this paper we configured AMOUR with 5 thrusters as shown in Figure 1. The three yellow thrusters provide thrust along the robot's main axis for yaw, pitch, and forward speed control. The red and the green thrusters provide thrust for roll and depth control. We mounted the optical modem receiver alongside the top yellow thruster. AMOUR's main body houses the battery, the battery management board, the IMU (Inertial Measurement Unit), and a small PC [14]. This entire system weighs approximately 19.5kg and has a buoyancy of 3kg. We manually weighted the robot to obtain neutral buoyancy.

## B. System Software

This section presents the software running on our system in the order that data passes through it.

1) *Base Station and Optical Transmitter*: The human input device is an optional input device. If in use, the HID forms the beginning of the data chain. The HID contains an IMU, which computes a rotation matrix describing the attitude of the HID device. The IMU updates the attitude at 400Hz and forwards it over a serial link to a notebook computer at 80Hz.

The notebook computer runs the user interface. It displays the HID's position and allows the user to set the robot's depth, speed, and maximum thruster limits. If the HID is disabled or not used, the user interface allows the setting of the robot's attitude and forms the first link in the data chain. The user interface runs at 80Hz and forwards all information to the optical transmitter over a serial link at 80Hz.

The optical transmitter runs a 400Hz loop. On every iteration a new packet containing the newest desired robot position is queued into the transmitter queue. Every packet is 37 bytes long and is composed of a 4 byte header, 32 bytes of payload data, and a CRC byte. The payload data consists of 16 values of 2 bytes each, containing: (1) the rotation matrix describing the desired robot attitude (9 entries), (2) the robot's desired depth (1 entry), (3) the maximum allowed thruster speeds (1 entry), and (4) the desired translational robot speed (3 entries). The 15th value is reserved for future use and the 16th value contains an additional CRC check. For the DPIM encoding, we chose a pulse length of 2us with a minimum guard interval of 2us and a difference between symbols of 2us. This results in an average data rate of 200Kbps. The maximum transmission time for a packet was 1.48ms with a guard interval maintaining a transmission rate of 400 packets per second.

2) *Optical Receiver and Robot*: For the robot the optical receiver is the first link in the data chain. A loop running at 1000Hz checks for received packets with correct CRC values. It then updates an internal desired robot state vector. This vector, along with the time passed since the last update, is forwarded over a serial link to the PC inside the robot at 25Hz.

The PC checks that the desired robot state is not older than 1 second. If it is older, the PC invalidates the state, otherwise the state is marked as valid. If the state is valid, the PC directly forwards the state to the IMU at 12.5Hz. If the state is invalid, the PC modifies the state to set the maximum thruster speed to zero and forwards the modified state to the IMU. This is a safety feature to disable the robot in case the optical link fails. Once the PC receives a valid

state (newer than 1 second), it slowly ramps the maximum thruster speed to the value set in the desired robot state. The PC logs all data received from the optical receiver. It also logs the robot's attitude and thruster speeds which it receives from the robot's IMU at 80Hz.

The IMU estimates the robot's position at 400Hz and updates the thruster outputs at 80Hz. The IMU uses the Modular Thruster Control Algorithm presented in [1] to orient and position the robot into the desired attitude.

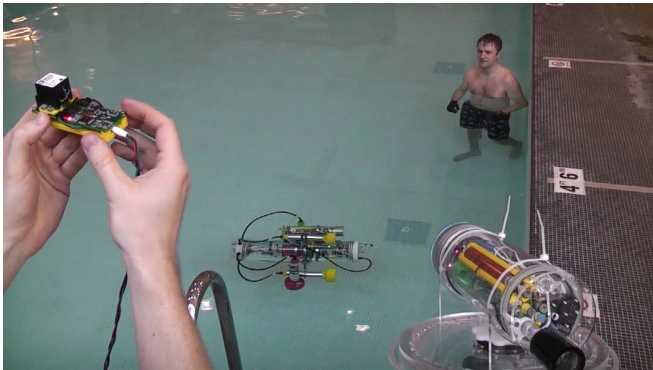

Fig. 5. Picture of the robot in the pool. The HID is at left and the optical transmitter is at right.

#### IV. EXPERIMENTS

In this section, we describe a set of experiments we performed to characterize the operation of the optical modem by itself and in conjunction with the robot. First, we present ranging experiments we performed in air, in a pool, and in the Singapore Harbor. These ranging experiments were performed without use of the robot. Next, we characterize the details of using the optical modem to control the robot in a pool. And finally, we demonstrate using the human input device over the the optical modem link to control the robot in the pool. Figure 5 shows a picture of the HID, robot, and optical transmitter from left to right.

These experiments show that we are able to obtain good optical communication ranges under a variety of conditions and are able to have full control of the robot in a pool while using only a single stationary transmitter. Additionally, our optical modem has a sufficiently high bitrate and low latency to allow easy and intuitive wireless control of the robot using our HID device.

##### A. Optical Modem

We performed optical modem experiments under three different conditions to characterize the range of the optical modem. For other experimental characterizations of the optical modem see [13].

Our first experiment occurred at night along a lit street with a length of 200m. We performed it in air, utilizing a bitrate of 1.2Mbps. For distances up to 150m the optical modem received 100 percent of the packets. At the full distance of 200m, the optical modem received 70 percent of the packets.

Our second experiment took place in a swimming pool with normal lighting using a speed setting of 1.2Mbps. The

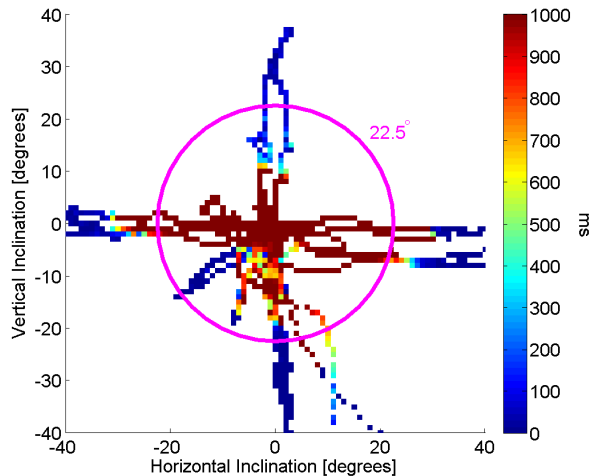

Fig. 6. Reception in the center of the pool with the receiver pointed towards the ceiling. The x-axis corresponds to inclination of the receiver along the short side of the pool. Negative values indicate the receiver pointing towards the left side of the pool and positive values towards the right side. The y-axis corresponds to inclination of the receiver along the long side of the pool. Negative values indicate the receiver pointing towards the transmitter and positive values away from the transmitter (which is located towards the lower right). The origin corresponds to the receiver pointing straight up at the ceiling.

transmitter and receiver were both submerged at a depth of 1m. At 30m, the full length of the pool, the optical modem received 100 percent of the packets.

We performed the final experiment in the Singapore Harbor. The optical transmitter and receiver were attached along a rigid 10m pole at varying separations and then lowered into the water to a depth of approximately 2m. This location had water with extremely low visibility, estimated to be 1.5m. Using a bitrate of 600Kbps, we received 100 percent of the packets when the transmitter and receiver were separated by 7m. After this range, the success rate dropped off quickly with only 40 percent success at 8m and virtually no correct packets at 9m separation. While the Singapore Harbor experiment achieved a shorter maximum range than the pool experiment, the maximum range obtained was over five times the maximum visibility distance.

##### B. Optical Modem in Pool

In this experiment, we attached the optical modem receiver to the robot and manually moved the robot at various angles throughout the pool to characterize the system at various locations in the pool. We fixed the optical transmitter location and orientation approximately in line with the right edge of the pool and 1 meter below the bottom edge of the pool as seen in Figure 7. The transmitter was elevated 2m above the water surface and was pointed at the center of the pool. We chose to position the transmitter outside of the water to achieve a good illumination of the entire pool area while simultaneously avoiding saturation of the receiver at close range. The pool is 13.7m long and 7.3m wide. The depth along the right side is 1.4m and along the left side is 1.1m.

Figure 7 shows the results of the experiments. We moved the robot along each edge of the pool as well as along the diagonals with the optical modem aimed in five different

orientations, pointing: towards the transmitter, to the left as viewed from the transmitter, away from the transmitter, to the right, and down towards the pool floor. The optical transmitter sent packets to the robot at a rate of 400Hz or a packet every 2.5ms. Every 25ms a monitor loop on the optical receiver side recorded the time since the last valid packet.

Figure 7 plots the received packet delays for each receiver orientation. For each orientation, we moved the robot along the boundary of the pool and across the diagonals. We discretized the pool and averaged delays within each bin. As packets are expected every 2.5ms, any packet delay of less than 2.5ms (blue-yellow) indicates near perfect receipt. Red bins indicate that the average delay was 5ms, corresponding to a success rate of about 50 percent. For all of these experiments the receiver was able to receive a significant fraction of the packets sent. This is a somewhat surprising result given that the receiver pointed away from the transmitter for most of the experiment. This can be explained by the sensitivity of the receiver and the white, reflective surface of the pool.

Interestingly, when the receiver was aimed to the right, perpendicular to the transmitter, the receiver obtained the best average receipt rate. The upper right corner and lower edge of the pool tended to be areas of weak reception in most configurations. In these positions, the pool edge shadows the receiver.

Perhaps the most unexpected result is that when the optical receiver was aimed towards the transmitter (far left figure), we saw the worst reception in the upper left quadrant. We believe this is due to an over-saturation of the receiver given that it was aimed nearly directly at the transmitter, which also had a large, sunny window behind it.

The only orientation where the optical modem performed poorly was when it was oriented directly up towards the ceiling. In this configuration, the optical modem rarely received data. We believe that this was caused by the lack of reflective surfaces and overpowering of the receiver by the overhead lights in the pool. Figure 6 shows an analysis of the angle at which the optical modem could receive data while pointed up in the center of the pool. Red indicates poor or no reception and blue indicates good reception. The angle of the robot was manually adjusted to explore the range at which the optical system could receive data. The circle indicates an angle of 22.5 degrees. Around this angle the optical modem started receiving data.

### C. Remote Robot Operation Using the Optical Modem

In this experiment, we used the HID to control the desired orientation of the robot. We transmitted the desired orientation to the robot over the optical communication link. Users of the system indicated that the system was very responsive and could not differentiate between a tethered configuration and the configuration using the optical link.

Figure 8 shows the results of the HID performance during two segments of the experiment. In the left figure, the robot was in an area with poor reception seeing an average latency of 104.3ms. In the right figure, it was in an area with good

reception seeing an average latency of 43.4ms. Over the course of the whole experiment the average latency was 51.4ms. The top four lines in the figures are values from the 3x3 rotation matrix. These uniquely define the rotation matrix of the robot up to some sign ambiguities. The desired orientation as output from the HID on the transmitter side is in green and the command received via the optical link by the robot is in black. At the bottom of the plot the red line indicates the time since the last valid packet was received.

For most of the time, the transmitter and receiver had the same target orientations. However, in the middle of the left plot, there are periods where the optical link experienced high latency. During these periods, the received data deviates from the transmitted data for short periods of time, causing a step function in the data (such as seen around 40 seconds). When this delay exceeded one second, which occurs only twice in the left plot, the thrusters were automatically disabled as a safety precaution. This prevents the robot from operating with old target orientation and speed information. Once a new transmission was received, operation resumed.

## V. CONCLUSIONS AND FUTURE WORK

In this paper, we described a wireless underwater optical modem that allows real-time control of our underwater robot. The optical modem is a high-speed, low-latency link that can be used in environments with obstacles, where typical tethered operation would be impossible. We briefly described both the hardware and software systems.

We verified the system in a number of experiments. First, we analyzed the range performance of the optical modem in air, pool, and Singapore's Harbor. We then presented experimental data from a pool experiment. This experiment showed that a single stationary transmitter could transmit information to the robot throughout the pool regardless of receiver orientation with the exception of poor reception when pointed directly up. Finally, we presented experiments remotely controlling the robot with a human input device. The operation of the HID demonstrates robust optical link performance and sufficiently low latency to allow real-time control and operation of the robot.

### A. Discussion

We showed that optical communication for underwater robot control allows data rates on the order of megabits per second and latency on the order of a millisecond. In comparison acoustic communication achieves data rates on the order of kilobits per second and latencies of multiple hundred milliseconds. The disadvantage of underwater optical communication is the reduced communication range of tens of meters when compared to ranges of multiple kilometers achieved with acoustic communication. A further disadvantage of underwater optical communication is that ambient light can saturate the receiver. Ambient light is a predominant problem at low depths, as in the case of the system presented in this paper, which is designed to operate at depths of up to 100m. We showed that our system can deal with ambient light in cases where the receiver is not

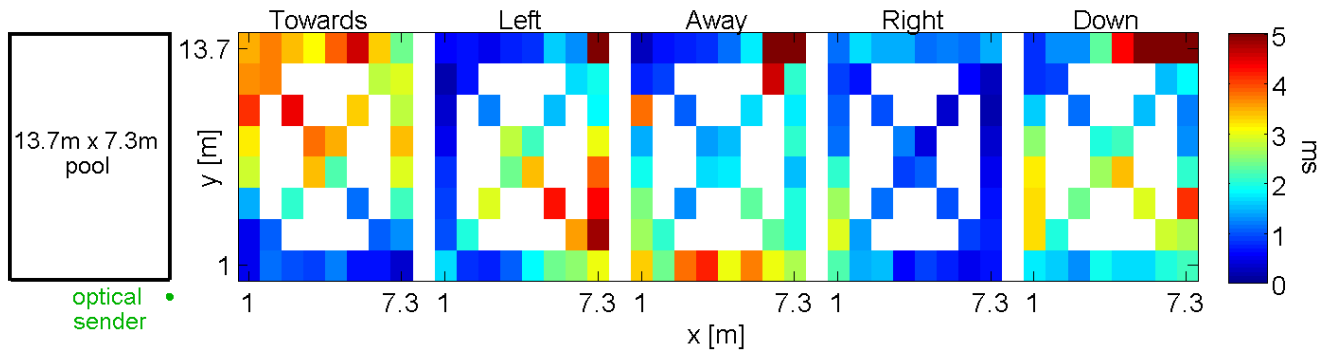

Fig. 7. Average time since last valid packet received during IMU update.

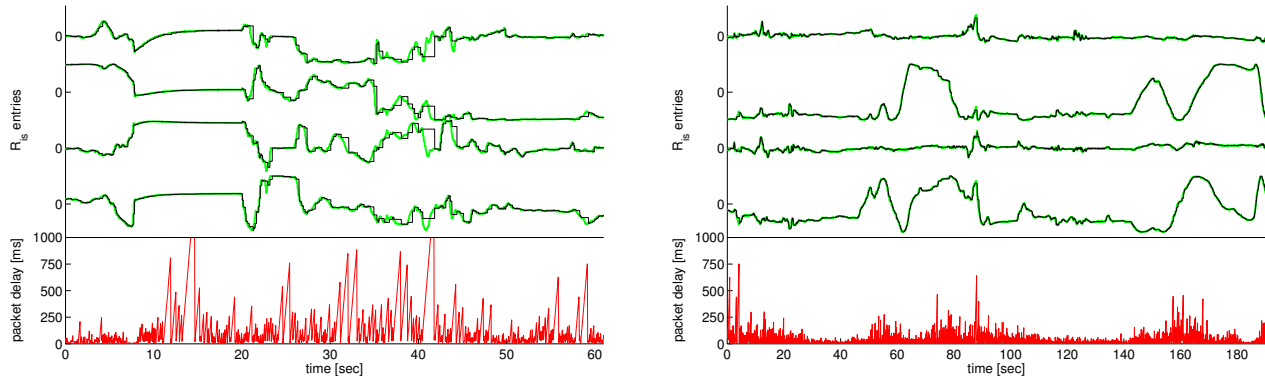

Fig. 8. Performance of the optical system while using HID. The top lines in the figures indicate the values transmitted (green) and received (black). The lower red lines plot the reception delay. At left, the robot was in an area with poor reception and, at right, an area with good reception.

directly pointed at a light source, e.g. the sun or overhead lamps in the pool. A further challenge of shallow waters is the increased turbidity due to surface currents and waves.

### B. Future Work

In the near future, we plan to add an optical transmitter to the robot to create a bi-directional link. This will enable the robot to transmit high-fidelity real-time data back to the user, such as video streams. Additionally we want to use a single optical link to control many robots at once. Using the current infrastructure, we have the bandwidth available to control tens of robots and the potential to expand the system to control over a hundred robots in the water. With the bi-directional system, the robots could communicate with high-speed links to enable groups of robots to autonomously and collaboratively perform tasks.

We also plan to deploy the system in larger pools and continue our experiments in limited visibility water such as the Singapore Harbor. In these waters, we expect the link to be far more directional and lower quality. Since this could cause the robot not to receive commands for an extended period of time, we will need to take advantage of the autonomous capabilities of the robot. In these situations, the optical link may be best used to update mission parameters and obtain near real-time images and videos from the robot.

## VI. ACKNOWLEDGMENTS

We would like to acknowledge the following groups for their financial support: DSTA Singapore, NSF, and Smarts MURI. We would like to thank the following people for assistance: Elizabeth Basha, Josh Karges, and David Stein.

## REFERENCES

- [1] M. Doniec, I. Vasilescu, C. Detweiler, and D. Rus, "Complete se(3) underwater robot control with arbitrary thruster configurations," in *Proc ICRA*, Anchorage, AK, May 2010.
- [2] M. A. Channey, "Short range underwater optical communication links," Master's thesis, North Carolina State University, 2005.
- [3] J. Smart, "Underwater optical communications systems part 1: variability of water optical parameters," in *Military Communications Conference*, 2005, pp. 1140–1146 Vol. 2.
- [4] B. Cochenour, L. Mullen, A. Laux, and T. Curran, "Effects of multiple scattering on the implementation of an underwater wireless optical communications link," in *OCEANS*, Boston, MA, Sept. 2006.
- [5] J. Giles and I. Bankman, "Underwater optical communications systems. part 2: basic design considerations," *Military Communications Conference*, pp. 1700–1705 Vol. 3, Oct. 2005.
- [6] Y. Tsuchida, H. N., and T. M., "An optical telemetry system for underwater recording of electromyogram and neuronal activity from non-tethered crayfish," *J of Neuroscience Methods*, 2004.
- [7] F. Schill, U. R. Zimmer, and J. Trumpf, "Visible spectrum optical communication and distance sensing for underwater applications," in *AGRA*, 2004.
- [8] F. Hanson and S. Radic, "High bandwidth underwater optical communication," *Appl. Opt.*, vol. 47, no. 2, pp. 277–283, 2008.
- [9] N. Farr, A. Chave, L. Freitag, J. Preisig, S. White, D. Yoerger, and F. Sonnichsen, "Optical modem technology for seafloor observatories," in *OCEANS*, Boston, MA, Sept. 2006.
- [10] N. Farr, A. Bowen, J. Ware, and C. Pontbriand, "An integrated, underwater optical / acoustic communications system," in *Proc MTS/IEEE OCEANS*, Seattle, WA, Sept. 2010.
- [11] I. Vasilescu, K. Kotay, D. Rus, M. Dunbabin, and P. Corke, "Data collection, storage, and retrieval with an underwater sensor network," in *SenSys*, 2005, pp. 154–165.
- [12] C. Detweiler, I. Vasilescu, and D. Rus, "An underwater sensor network with dual communications, sensing, and mobility," June 2007.
- [13] M. Doniec, I. Vasilescu, M. Chitre, C. Detweiler, M. Hoffmann-Kuhnt, and D. Rus, "Aquaoptical: A lightweight device for high-rate long-range underwater point-to-point communication," in *OCEANS*, Biloxi, MS, Oct. 2009.
- [14] CompuLab. (2009) fit-pc2 wiki. [Online]. Available: <http://fit-pc2.com/>